



Approved Performance by API

Oilfield Roller Chains | API



Oilfield - Roller Chains

Approved Performance by API.

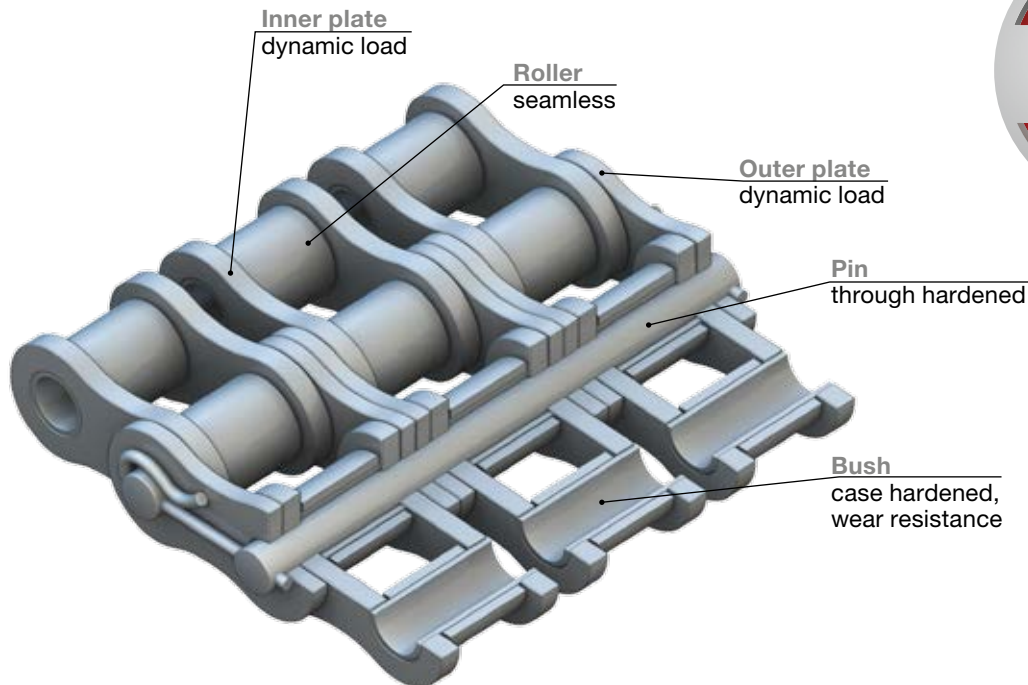

APPLICATIONS

- Petrochemical Industry
- Rig Draw works, mud pumps, transmission drives

FEATURES

- High dynamic load capacity
- Good wear resistance
- Reliable factory lubrication
- Shock resistant rollers
- Shot peened components
- Sideplates, rollers and pins are through hardened
- Solid rollers
- Sideplates holes are ball drifted

BENEFITS

- Small run-in elongation
- Durability
- Very high impact strength
- Very robust in difficult conditions
- Maximum reliability
- Improved economy

LUBRICATION

- Excellent protection by RexPro lubrication without the use of heavy metals
- Operating temperature: -30° C to +130° C (from -40° C extended to +250° C)
- Very good surface adhesion; no drip even at high temperatures
- Without heavy metals, free of silicone and Teflon

Link-Belt - Oilfield Roller Chains



Pioneering corrosion protection

- 8-10 times better corrosion protection than the best competitor
- 100 % better than the competitors in the Stiffness Test in aggressive surroundings



Improved wear protection

- 8-12 % against the wear compared to previous version
- RexPro lubricant offers more than 150 % better protection against the cold welding



High dynamic loading resistance

- Ball drifting of the plate holes
- All chain parts are shot peened to improve fatigue resistance
- Link-Belt roller chains are pre-run-in under high load
- Rollers are high fatigue strength for resisting running-in impacts



OF - Mark of Link-Belt Quality

Link-Belt oil field roller chains bear the trade mark „OF as a symbol of their special suitability for use in oil-drilling operations. The trade marks stands for high precision, absolute dependability and long life. It is your assurance of excellent products from a leading modern chain manufacturer.

Oilfiled - Roller Chains - ANSI

Approved Performance by API.

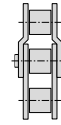

1-Strand Roller Chains



Pioneering corrosion protection

- 8-10 times better corrosion protection than the best competitor
- 100% better than the competitors in the Stiffness Test in aggressive surroundings



Improved wear protection

- 8-12% against the wear compared to previous version
- RexPro lubricant offers more than 150% better protection against the cold welding



High dynamic loading resistance

- Ball drifting of the plate holes
- All chain parts are shot peened to improve fatigue resistance
- Link-Belt roller chains are pre-run-in under high load
- Rollers are high fatigue strength for resisting running-in impacts

Single-Strand Roller Chains, Ansi

Inch

Chain No.	Pitch	Dimension in inches										Bearing Area	Min. Ultimate strength	Weight	Outer Link	Loose Parts	
		ansi	p inch	b ₁ min.	d ₁ max.	d ₂ max.	b ₂ max.	g max.	e	a ₁ max.	a ₃ max.					s	A inch ²
RC 50-1*	0.625		0.37	0.40	0.20	0.54	0.59	-	0.80	0.91	0.08	0.11	5,000	0.74	A	E	L
RC 60-1*	0.750		0.50	0.47	0.23	0.70	0.70	-	1.01	1.13	0.09	0.16	7,100	1.14	A	E	L
RC 80FR EW-1	1.000		0.62	0.63	0.31	0.89	0.93	-	1.30	1.50	0.13	0.28	12,700	1.31	H	L	H
RC 100FR EW-1	1.250		0.74	0.75	0.38	1.08	1.15	-	1.55	1.77	0.16	0.41	20,000	2.76	H	L	H
RC 120FR EW-1	1.500		0.99	0.88	0.44	1.39	1.36	-	1.96	2.21	0.19	0.61	28,600	4.03	H	L	H
RC 140FR EW-1	1.750		0.99	1.00	0.50	1.46	1.61	-	2.10	2.34	0.22	0.76	38,800	5.28	H	L	H
RC 160FR EW-1	2.000		1.24	1.13	0.56	1.77	1.88	-	2.51	2.71	0.25	1.01	51,000	7.55	H	L	H
RC 180FR EW-1	2.250		1.41	1.41	0.69	2.00	2.13	-	2.81	3.15	0.28	1.37	63,400	10.26	T	T	L
RC 200FR EW-1	2.500		1.49	1.56	0.78	2.16	2.36	-	3.07	3.45	0.32	1.69	79,500	12.31	H	S	L
RC 240FR EW-1	3.000		1.87	1.88	0.94	2.66	2.76	-	3.74	4.20	0.37	2.50	114,000	18.46	H	S	L

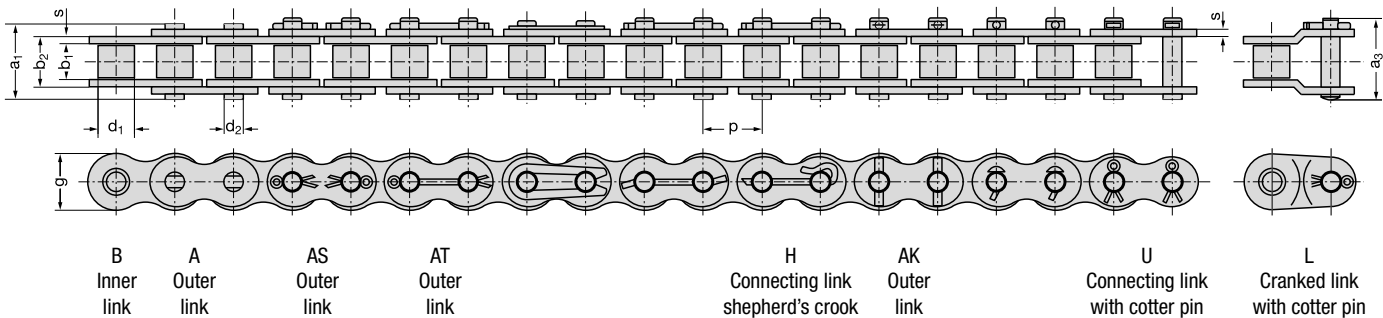

MODULE_06/D/2014/02 // No liability accepted for misprints or errors!

Oilfiled - Roller Chains - ANSI

Approved Performance by API.

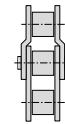

1-Strand Roller Chains



Pioneering corrosion protection

- 8 - 10 times better corrosion protection than the best competitor
- 100 % better than the competitors in the Stiffness Test in aggressive surroundings



Improved wear protection

- 8 - 12 % against the wear compared to previous version
- RexPro lubricant offers more than 150 % better protection against the cold welding



High dynamic loading resistance

- Ball drifting of the plate holes
- All chain parts are shot peened to improve fatigue resistance
- Link-Belt roller chains are pre-run-in under high load
- Rollers are high fatigue strength for resisting running-in impacts



Metric

Single-Strand Roller Chains, Ansi

Chain No.	Pitch	Dimension in mm										Bearing Area A cm ²	Min. Ultimate strength F _B N	Weight ~q kg/m	Outer Link Stand. Type	Loose Parts		
		p mm	b ₁ min.	d ₁ max.	d ₂ max.	b ₂ max.	g max.	e	a ₁ max.	a ₃ max.	s					E	L	
RC 50-1*	15.875	9.40	10.16	5.08	13.80	15.08	-	20.40	23.00	2.00	0.70	22,200	1.01	A	E	L		
RC 60-1*	19.050	12.57	11.91	5.94	17.70	17.70	-	25.70	28.60	2.40	1.06	31,800	1.55	A	E	L		
RC 80FR EW-1	25.400	15.75	15.88	7.92	22.50	23.50	-	33.00	38.00	3.20	1.79	56,700	1.79	H	L	H		
RC 100FR EW-1	31.750	18.90	19.05	9.53	27.40	29.20	-	39.40	44.90	4.00	2.62	88,500	3.76	H	L	H		
RC 120FR EW-1	38.100	25.22	22.23	11.10	35.30	34.40	-	49.80	56.10	4.70	3.94	127,000	5.50	H	L	H		
RC 140FR EW-1	44.450	25.22	25.40	12.70	37.00	40.80	-	53.40	59.30	5.50	4.92	172,400	7.20	H	L	H		
RC 160FR EW-1	50.800	31.55	28.58	14.27	45.00	47.80	-	63.60	68.90	6.30	6.50	226,800	10.30	H	L	H		
RC 180FR EW-1	57.150	35.72	35.71	17.46	50.70	54.00	-	71.30	79.90	7.00	8.85	282,000	14.00	T	T	L		
RC 200FR EW-1	63.500	37.85	39.68	19.84	54.70	60.00	-	78.00	87.50	8.00	10.90	353,800	16.80	H	S	L		
RC 240FR EW-1	76.200	47.35	47.63	23.80	67.50	70.00	-	94.80	106.70	9.50	16.14	510,300	25.18	H	S	L		

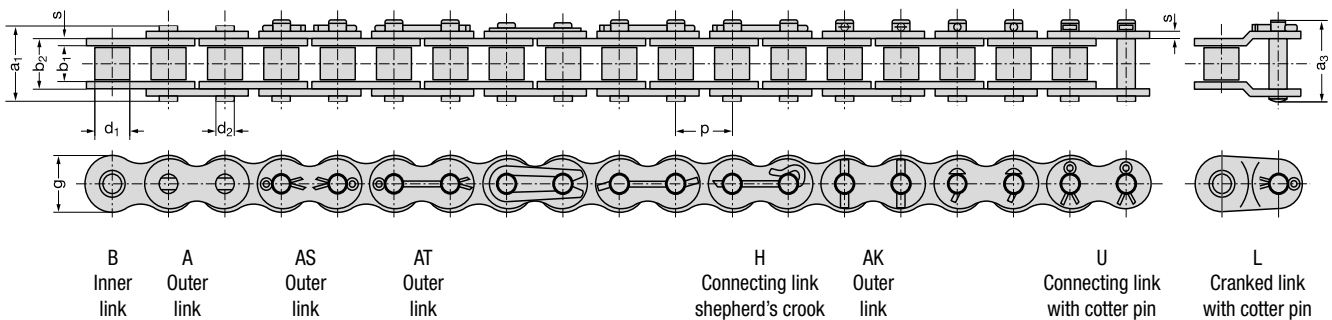

Oilfiled - Roller Chains - ANSI

Approved Performance by API.

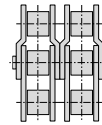

2-Strand Roller Chains



Pioneering corrosion protection

- 8 - 10 times better corrosion protection than the best competitor
- 100 % better than the competitors in the Stiffness Test in aggressive surroundings



Improved wear protection

- 8 - 12 % against the wear compared to previous version
- RexPro lubricant offers more than 150 % better protection against the cold welding



High dynamic loading resistance

- Ball drifting of the plate holes
- All chain parts are shot peened to improve fatigue resistance
- Link-Belt roller chains are pre-run-in under high load
- Rollers are high fatigue strength for resisting running-in impacts

Double-Strand Roller Chains, Ansi

Inch

Chain No.	Pitch	Dimension in inches										Bearing Area	Min. Ultimate strength	Weight	Outer Link	Loose Parts
		p inch	b ₁ min.	d ₁ max.	d ₂ max.	b ₂ max.	g max.	e	a ₁ max.	a ₃ max.	s					
RC 50-2*	0.625	0.37	0.40	0.20	0.54	0.59	0.71	1.52	1.63	0.08	0.22	10,000	1.48	A	E	L
RC 60-2*	0.750	0.50	0.47	0.23	0.70	0.70	0.90	1.91	2.03	0.09	0.33	14,300	2.13	A	U	L
RC 80FR EW-2	1.000	0.62	0.63	0.31	0.89	0.93	1.15	2.46	2.64	0.13	0.55	25,500	3.81	H	L	H
RC 100FR EW-2	1.250	0.74	0.75	0.38	1.08	1.15	1.41	2.97	3.18	0.16	0.81	39,800	5.57	H	L	H
RC 120FR EW-2	1.500	0.99	0.88	0.44	1.39	1.36	1.79	3.75	4.00	0.19	1.22	57,100	7.92	H	L	H
RC 140FR EW-2	1.750	0.99	1.00	0.50	1.46	1.61	1.93	4.03	4.32	0.22	1.46	77,500	10.41	H	L	H
RC 160FR EW-2	2.000	1.24	1.13	0.56	1.77	1.88	2.31	4.81	5.13	0.25	2.02	102,000	14.29	H	L	H
RC 180FR EW-2	2.250	1.41	1.41	0.69	2.00	2.13	2.54	5.39	5.73	0.28	2.74	127,000	19.88	K	K	L
RC 200FR EW-2	2.500	1.49	1.56	0.78	2.16	2.36	2.82	5.89	6.27	0.32	3.38	160,000	23.97	H	S	L
RC 240FR EW-2	3.000	1.87	1.88	0.94	2.66	2.76	3.46	7.20	7.67	0.37	5.00	230,000	36.50	H	S	L

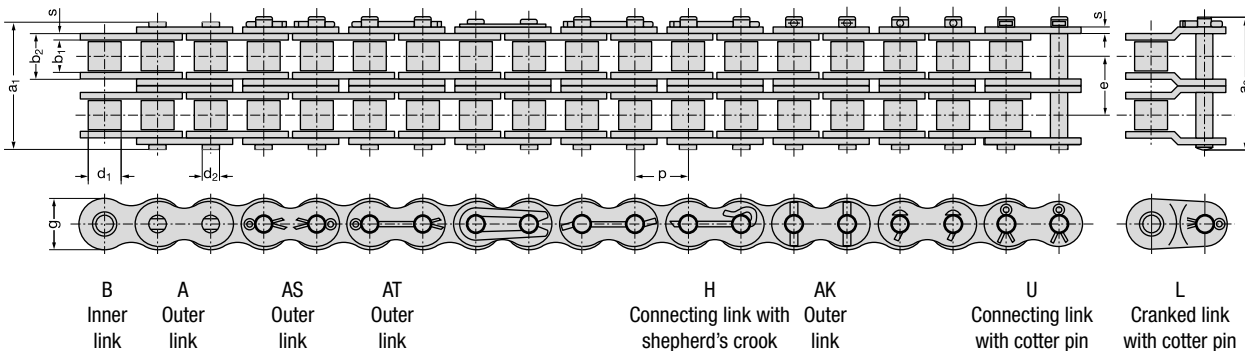

MODULE_06/D/2014/02 // No liability accepted for misprints or errors!

Oilfiled - Roller Chains - ANSI

Approved Performance by API.

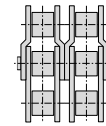

2-Strand Roller Chains



Pioneering corrosion protection

- 8 - 10 times better corrosion protection than the best competitor
- 100 % better than the competitors in the Stiffness Test in aggressive surroundings



Improved wear protection

- 8 - 12 % against the wear compared to previous version
- RexPro lubricant offers more than 150 % better protection against the cold welding



High dynamic loading resistance

- Ball drifting of the plate holes
- All chain parts are shot peened to improve fatigue resistance
- Link-Belt roller chains are pre-run-in under high load
- Rollers are high fatigue strength for resisting running-in impacts



Metric

Double-Strand Roller Chains, Ansi

Chain No.	Pitch	Dimension in mm										Bear- ing Area A cm ²	Min. Ultimate strength F _b N	Weight ~q kg/m	Outer Link Stand. Type	Loose Parts	
		p mm	b ₁ min.	d ₁ max.	d ₂ max.	b ₂ max.	g max.	e	a ₁ max.	a ₃ max.	s					E	L
RC 50-2*	15.875	9.40	10.16	5.08	13.80	15.08	18.11	38.50	41.30	2.00	1.40	44,400	2.02	A	E	L	
RC 60-2*	19.050	12.57	11.91	5.94	17.70	17.70	22.78	48.50	51.50	2.40	2.12	63,600	2.90	A	U	L	
RC 80FR EW-2	25.400	15.75	15.88	7.92	22.50	23.50	29.29	62.40	67.10	3.20	3.58	113,400	5.20	H	L	H	
RC 100FR EW-2	31.750	18.90	19.05	9.53	27.40	29.20	35.76	75.30	80.70	4.00	5.24	177,000	7.60	H	L	H	
RC 120FR EW-2	38.100	25.22	22.23	11.10	35.30	34.40	45.44	95.30	101.60	4.70	7.88	254,000	10.80	H	L	H	
RC 140FR EW-2	44.450	25.22	25.40	12.70	37.00	40.80	48.87	102.20	109.60	5.50	9.44	344,800	14.20	H	L	H	
RC 160FR EW-2	50.800	31.55	28.58	14.27	45.00	47.80	58.55	122.10	130.10	6.30	13.00	453,600	19.50	H	L	H	
RC 180FR EW-2	57.150	35.72	35.71	17.46	50.70	54.00	64.52	136.70	145.40	7.00	17.70	564,000	27.12	K	K	L	
RC 200FR EW-2	63.500	37.85	39.68	19.84	54.70	60.00	71.55	149.60	159.20	8.00	21.80	707,600	32.70	H	S	L	
RC 240FR EW-2	76.200	47.35	47.63	23.80	67.50	70.00	87.83	182.70	194.70	9.50	32.28	1,020,600	49.80	H	S	L	

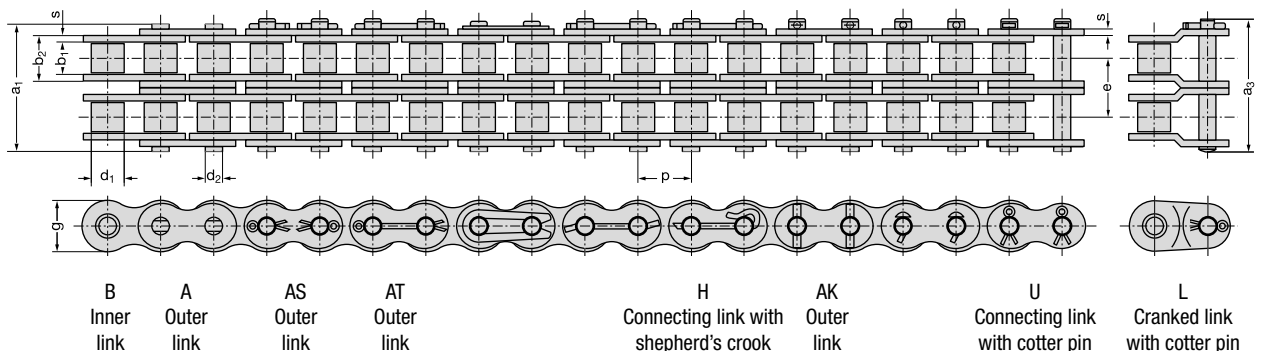

Oilfiled - Roller Chains - ANSI

Approved Performance by API.

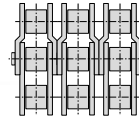

3-Strand Roller Chains



Pioneering corrosion protection

- 8-10 times better corrosion protection than the best competitor
- 100% better than the competitors in the Stiffness Test in aggressive surroundings



Improved wear protection

- 8-12% against the wear compared to previous version
- RexPro lubricant offers more than 150% better protection against the cold welding



High dynamic loading resistance

- Ball drifting of the plate holes
- All chain parts are shot peened to improve fatigue resistance
- Link-Belt roller chains are pre-run-in under high load
- Rollers are high fatigue strength for resisting running-in impacts

Triple-Strand Roller Chains, Ansi

Inch

Chain No.	Pitch	Dimension in inches										Bearing Area	Min. Ultimate strength	Weight	Outer Link	Loose Parts	
		Ans	p inch	b ₁ min.	d ₁ max.	d ₂ max.	b ₂ max.	g max.	e	a ₁ max.	a ₃ max.					s	A inch ²
RC 50-3*	0.625		0.37	0.40	0.20	0.54	0.59	0.71	2.23	2.36	0.08	0.33	15,000	2.23	A	E	L
RC 60-3*	0.750		0.50	0.47	0.23	0.70	0.70	0.90	2.81	2.88	0.09	0.49	21,400	3.17	A	U	L
RC 80FR EW-3	1.000		0.62	0.63	0.31	0.89	0.93	1.15	3.61	3.85	0.13	0.83	38,200	5.79	H	L	H
RC 100FR EW-3	1.250		0.74	0.75	0.38	1.08	1.15	1.41	4.38	4.62	0.16	1.22	59,700	8.36	H	L	H
RC 120FR EW-3	1.500		0.99	0.88	0.44	1.39	1.36	1.79	5.54	5.84	0.19	1.83	85,600	11.58	H	L	H
RC 140FR EW-3	1.750		0.99	1.00	0.50	1.46	1.61	1.93	5.96	6.24	0.22	2.19	117,000	15.76	H	L	H
RC 160FR EW-3	2.000		1.24	1.13	0.56	1.77	1.88	2.31	7.12	7.43	0.25	3.02	153,000	19.28	H	L	H
RC 180FR EW-3	2.250		1.41	1.41	0.69	2.00	2.13	2.54	7.96	8.30	0.28	4.12	191,000	29.71	K	K	L
RC 200FR EW-3	2.500		1.49	1.56	0.78	2.16	2.36	2.82	8.71	8.03	0.32	5.07	239,000	35.77	H	S	L
RC 240FR EW-3	3.000		1.87	1.88	0.94	2.66	2.76	3.46	10.66	11.13	0.37	7.51	345,000	54.61	H	S	L

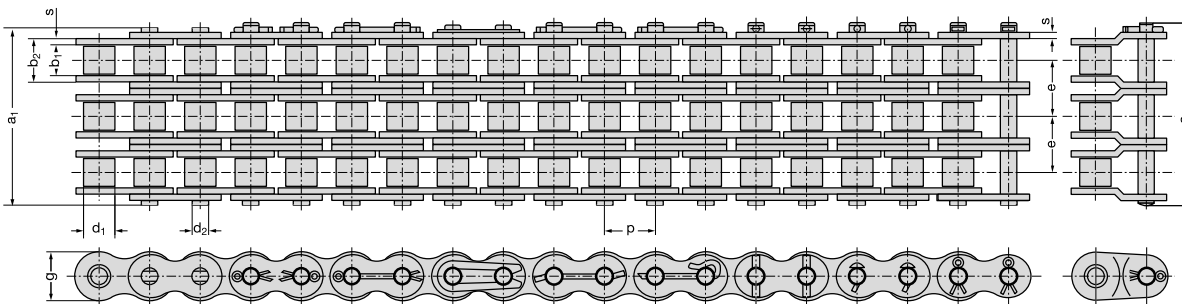

B Inner link A Outer link AS Outer link AT Outer link H Connecting link with shepherd's crook AK Outer link U Connecting link with cotter pin L Cranked link with cotter pin

Oilfiled - Roller Chains - ANSI

Approved Performance by API.

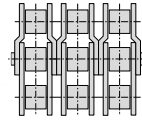

3-Strand Roller Chains



Pioneering corrosion protection

- 8 - 10 times better corrosion protection than the best competitor
- 100 % better than the competitors in the Stiffness Test in aggressive surroundings



Improved wear protection

- 8 - 12 % against the wear compared to previous version
- RexPro lubricant offers more than 150 % better protection against the cold welding



High dynamic loading resistance

- Ball drifting of the plate holes
- All chain parts are shot peened to improve fatigue resistance
- Link-Belt roller chains are pre-run-in under high load
- Rollers are high fatigue strength for resisting running-in impacts



Metric

Triple-Strand Roller Chains, Ansi

Chain No. Ansi	Pitch p mm	Dimension in mm										Bearing Area A cm ²	Min. Ultimate strength F _b N	Weight ~q kg/m	Outer Link Stand. Type	Loose Parts		
		b ₁ min.	d ₁ max.	d ₂ max.	b ₂ max.	g max.	e	a ₁ max.	a ₃ max.	s	E					U	L	
RC 50-3*	15.875	9.40	10.16	5.08	13.80	15.08	18.11	56.70	59.80	2.00	2.10	66,600	3.04	A	E	L		
RC 60-3*	19.050	12.57	11.91	5.94	17.70	17.70	22.78	71.30	73.00	2.40	3.18	95,400	4.32	A	U	L		
RC 80FR EW-3	25.400	15.75	15.88	7.92	22.50	23.50	29.29	91.70	97.70	3.20	5.37	170,100	7.90	H	L	H		
RC 100FR EW-3	31.750	18.90	19.05	9.53	27.40	29.20	35.76	111.10	117.20	4.00	7.86	265,500	11.40	H	L	H		
RC 120FR EW-3	38.100	25.22	22.23	11.10	35.30	34.40	45.44	140.70	148.30	4.70	11.82	381,000	15.80	H	L	H		
RC 140FR EW-3	44.450	25.22	25.40	12.70	37.00	40.80	48.87	151.20	158.50	5.50	14.16	517,200	21.50	H	L	H		
RC 160FR EW-3	50.800	31.55	28.58	14.27	45.00	47.80	58.55	180.70	188.70	6.30	19.50	680,400	26.30	H	L	H		
RC 180FR EW-3	57.150	35.72	35.71	17.46	50.70	54.00	64.52	202.00	210.70	7.00	26.55	846,000	40.53	K	K	L		
RC 200FR EW-3	63.500	37.85	39.68	19.84	54.70	60.00	71.55	221.10	203.70	8.00	32.70	1,061,400	48.80	H	S	L		
RC 240FR EW-3	76.200	47.35	47.63	23.80	67.50	70.00	87.83	270.60	282.50	9.50	48.42	1,530,900	74.50	H	S	L		

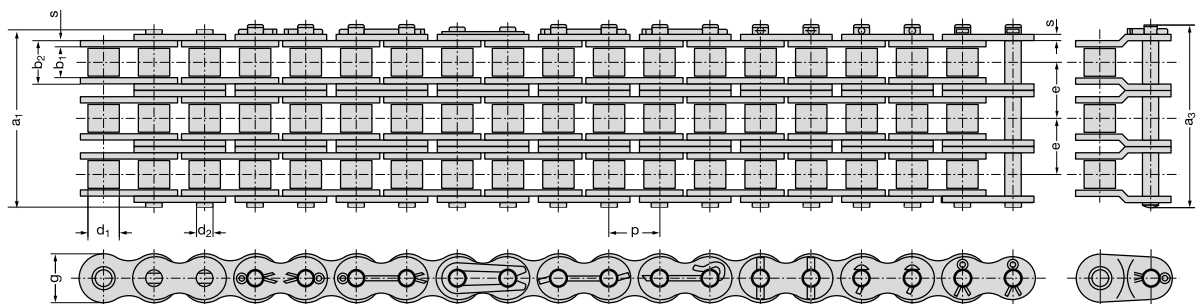

B Inner link A Outer link AS Outer link AT Outer link H Connecting link with shepherd's crook AK Outer link U Connecting link with cotter pin L Cranked link with cotter pin

Oilfiled - Roller Chains - ANSI

Approved Performance by API.

4-Strand Roller Chains



Pioneering corrosion protection

- 8 - 10 times better corrosion protection than the best competitor
- 100 % better than the competitors in the Stiffness Test in aggressive surroundings



Improved wear protection

- 8 - 12 % against the wear compared to previous version
- RexPro lubricant offers more than 150 % better protection against the cold welding



High dynamic loading resistance

- Ball drifting of the plate holes
- All chain parts are shot peened to improve fatigue resistance
- Link-Belt roller chains are pre-run-in under high load
- Rollers are high fatigue strength for resisting running-in impacts

Quadruple-Strand Roller Chains, Ansi

Inch

Chain No.	Pitch	Dimension in inches										Bearing Area	Min. Ultimate strength	Weight	Outer Link	Loose Parts
		p inch	b ₁ min.	d ₁ max.	d ₂ max.	b ₂ max.	g max.	e	a ₁ max.	a ₃ max.	s					
RC 50-4*	0.625	0.37	0.40	0.20	0.54	0.59	0.71	2.95	3.07	0.08	0.43	19,800	2.97	A	E	L
RC 60-4*	0.750	0.50	0.47	0.23	0.70	0.70	0.90	3.71	3.79	0.09	0.66	28,600	4.15	A	U	L
RC 80FR EW-4	1.000	0.62	0.63	0.31	0.89	0.93	1.15	4.77	5.03	0.13	1.11	51,000	7.33	H	L	H
RC 100FR EW-4	1.250	0.74	0.75	0.38	1.08	1.15	1.41	5.79	6.05	0.16	1.62	79,600	10.63	H	L	H
RC 120FR EW-4	1.500	0.99	0.88	0.44	1.39	1.36	1.79	7.34	7.68	0.19	2.44	115,000	15.76	H	L	H
RC 140FR EW-4	1.750	0.99	1.00	0.50	1.46	1.61	1.93	7.88	8.22	0.22	2.93	156,000	20.89	H	L	H
RC 160FR EW-4	2.000	1.24	1.13	0.56	1.77	1.88	2.31	9.42	9.74	0.25	4.03	204,000	27.85	H	L	H
RC 180FR EW-4	2.250	1.41	1.41	0.69	2.00	2.13	2.54	10.48	10.84	0.28	5.49	254,000	39.66	K	K	L
RC 200FR EW-4	2.500	1.49	1.56	0.78	2.16	2.36	2.82	11.53	12.06	0.32	6.76	319,000	46.91	H	S	L
RC 240FR EW-4	3.000	1.87	1.88	0.94	2.66	2.76	4.46	14.12	14.60	0.37	10.01	459,000	72.64	H	S	L

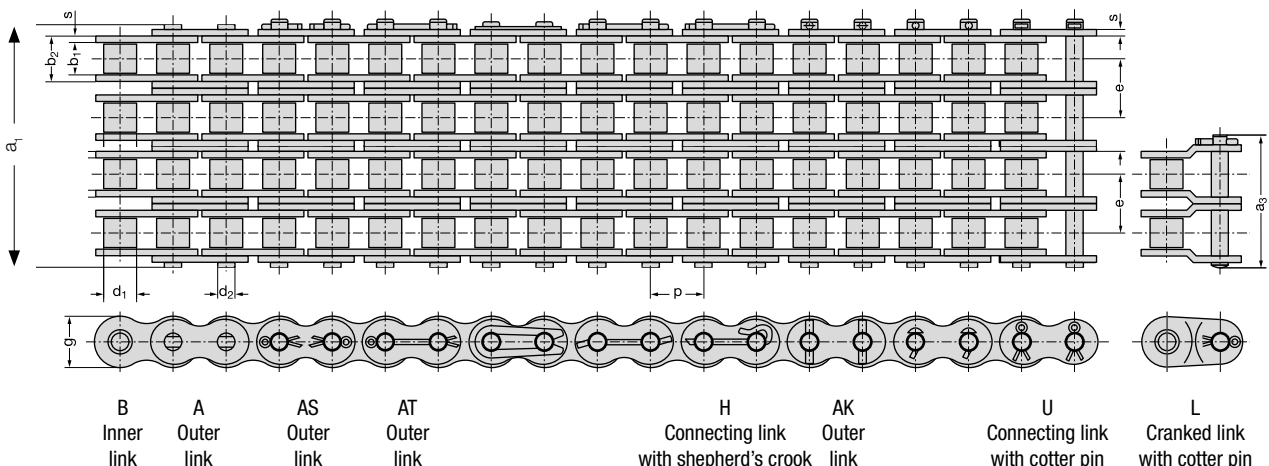

Oilfiled - Roller Chains - ANSI

Approved Performance by API.

4-Strand Roller Chains



Pioneering corrosion protection

- 8 - 10 times better corrosion protection than the best competitor
- 100 % better than the competitors in the Stiffness Test in aggressive surroundings



Improved wear protection

- 8 - 12 % against the wear compared to previous version
- RexPro lubricant offers more than 150 % better protection against the cold welding



High dynamic loading resistance

- Ball drifting of the plate holes
- All chain parts are shot peened to improve fatigue resistance
- Link-Belt roller chains are pre-run-in under high load
- Rollers are high fatigue strength for resisting running-in impacts



Metric Quadruple-Strand Roller Chain, Ansi

Chain No.	Pitch	Dimension in mm									Bearing Area	Min. Ultimate strength	Weight	Outer Link	Loose Parts		
		p	b_1 min.	d_1 max.	d_2 max.	b_2 max.	g max.	e	a_1 max.	a_3 max.					s	A	F_B
Ansi	p mm										cm ²	N	kg/m				
RC 50-4*	15.875	9.40	10.16	5.08	13.80	15.08	18.11	74.80	77.90	2.00	2.80	88,000	4.05	A	E	L	
RC 60-4*	19.050	12.57	11.91	5.94	17.70	17.70	22.78	94.10	96.10	2.40	4.24	127,200	5.66	A	U	L	
RC 80FR EW-4	25.400	15.75	15.88	7.92	22.50	23.50	29.29	121.00	127.70	3.20	7.16	226,800	10.00	H	L	H	
RC 100FR EW-4	31.750	18.90	19.05	9.53	27.40	29.20	36.76	146.90	153.50	4.00	10.48	354,000	14.50	H	L	H	
RC 120FR EW-4	38.100	25.22	22.23	11.10	35.30	34.40	45.44	186.20	194.80	4.70	15.76	508,000	21.50	H	L	H	
RC 140FR EW-4	44.450	25.22	25.40	12.70	37.00	40.80	48.87	200.00	208.60	5.50	18.88	689,600	28.50	H	L	H	
RC 160FR EW-4	50.800	31.55	28.58	14.27	45.00	47.80	58.55	239.20	247.30	6.30	26.00	907,200	38.00	H	L	H	
RC 180FR EW-4	2.250	1.41	1.41	0.69	2.00	2.13	2.54	10.48	10.84	0.28	5.49	254,000	39.66	K	K	L	
RC 200FR EW-4	2.500	1.49	1.56	0.78	2.16	2.36	2.82	11.53	12.06	0.32	6.76	319,000	46.91	H	S	L	
RC 240FR EW-4	3.000	1.87	1.88	0.94	2.66	2.76	4.46	14.12	14.60	0.37	10.01	459,000	72.64	H	S	L	

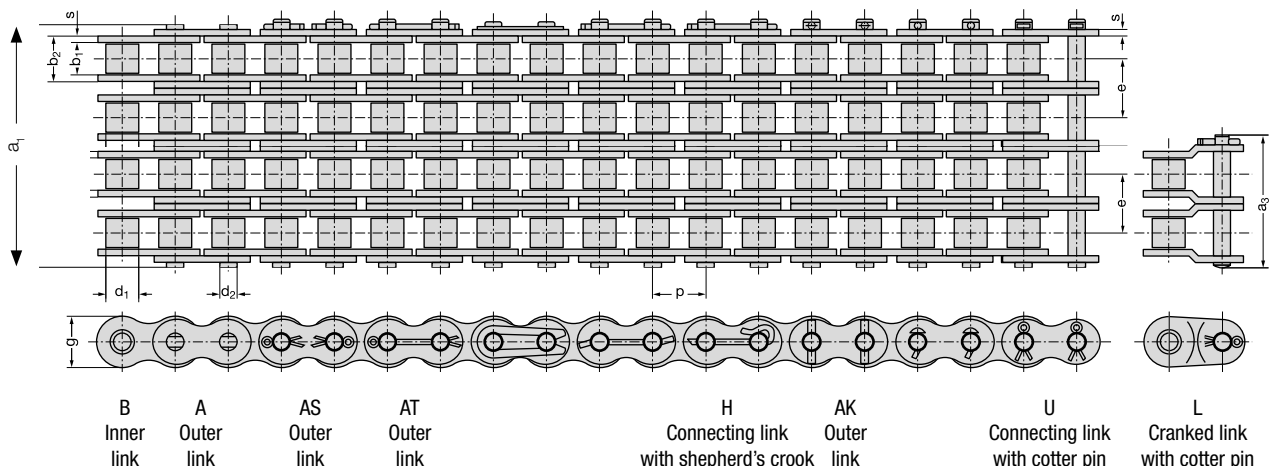

Oilfiled - Roller Chains - ANSI

Approved Performance by API.

5-Strand Roller Chains



Pioneering corrosion protection

- 8-10 times better corrosion protection than the best competitor
- 100% better than the competitors in the Stiffness Test in aggressive surroundings



Improved wear protection

- 8-12% against the wear compared to previous version
- RexPro lubricant offers more than 150% better protection against the cold welding



High dynamic loading resistance

- Ball drifting of the plate holes
- All chain parts are shot peened to improve fatigue resistance
- Link-Belt roller chains are pre-run-in under high load
- Rollers are high fatigue strength for resisting running-in impacts

Five-Strand Roller Chains, Ansi

Inch

Chain No.	Pitch	Dimension in inches										Bearing Area	Min. Ultimate strength	Weight	Outer Link	Loose Parts	
		ansi	p inch	b ₁ min.	d ₁ max.	d ₂ max.	b ₂ max.	g max.	e	a ₁ max.	a ₃ max.					s	A inch ²
RC 50-5*	0.625		0.37	0.40	0.20	0.54	0.59	0.71	3.66	3.78	0.08	0.54	25,000	3.76	A	E	L
RC 60-5*	0.750		0.50	0.47	0.23	0.70	0.70	0.90	4.61	4.69	0.09	0.82	35,700	5.13	A	U	L
RC 80FR EW-5	1.000		0.62	0.63	0.31	0.89	0.93	1.15	5.92	6.19	0.13	1.39	63,700	9.53	H	L	H
RC 100FR EW-5	1.250		0.74	0.75	0.38	1.08	1.15	1.41	7.19	7.47	0.16	2.03	99,500	13.93	H	L	H
RC 120FR EW-5	1.500		0.99	0.88	0.44	1.39	1.36	1.79	9.13	9.48	0.19	3.05	143,000	20.16	H	L	H
RC 140FR EW-5	1.750		0.99	1.00	0.50	1.46	1.61	1.93	9.81	10.14	0.22	3.65	194,000	27.49	H	L	H

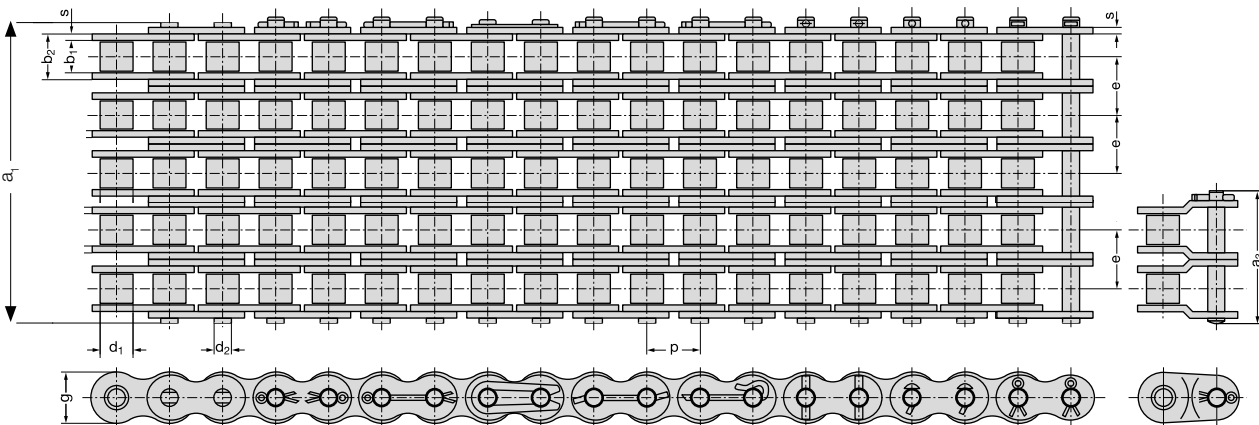

B Inner link A Outer link AS Outer link AT Outer link H Connecting link with shepherd's crook AK Outer link U Connecting link with cotter pin L Cranked link with cotter pin

MODULE_06/D/2014/02 // No liability accepted for misprints or errors!

Oilfiled - Roller Chains - ANSI

Approved Performance by API.

5-Strand Roller Chains



Pioneering corrosion protection

- 8 - 10 times better corrosion protection than the best competitor
- 100 % better than the competitors in the Stiffness Test in aggressive surroundings



Improved wear protection

- 8 - 12 % against the wear compared to previous version
- RexPro lubricant offers more than 150 % better protection against the cold welding



High dynamic loading resistance

- Ball drifting of the plate holes
- All chain parts are shot peened to improve fatigue resistance
- Link-Belt roller chains are pre-run-in under high load
- Rollers are high fatigue strength for resisting running-in impacts



Metric Five-Strand Roller Chains, Ansi

Chain No.	Pitch	Dimension in mm										Bearing Area A cm ²	Min. Ultimate strength F _B N	Weight ~q kg/m	Outer Link Stand. Type	Loose Parts	
		p mm	b ₁ min.	d ₁ max.	d ₂ max.	b ₂ max.	g max.	e	a ₁ max.	a ₃ max.	s					E	H
RC 50-5*	15.875	9.40	10.16	5.08	13.80	15.08	18.11	93.00	96.00	2.00	3.50	111,000	5.13	A	E	L	
RC 60-5*	19.050	12.57	11.91	5.94	17.70	17.70	22.78	116.90	119.10	2.40	5.30	159,000	7.00	A	U	H	
RC 80FR EW-5	25.400	15.75	15.88	7.92	22.50	23.50	29.29	150.30	157.00	3.20	8.95	283,500	13.00	H	L	H	
RC 100FR EW-5	31.750	18.90	19.05	9.53	27.40	29.20	35.76	182.60	189.00	4.00	13.10	442,500	19.00	H	L	H	
RC 120FR EW-5	38.100	25.22	22.23	11.10	35.30	34.40	45.44	231.60	240.50	4.70	19.70	635,000	27.50	H	L	H	
RC 140FR EW-5	44.450	25.22	25.40	12.70	37.00	40.80	48.87	248.90	257.40	5.50	23.56	862,000	37.50	H	L	H	

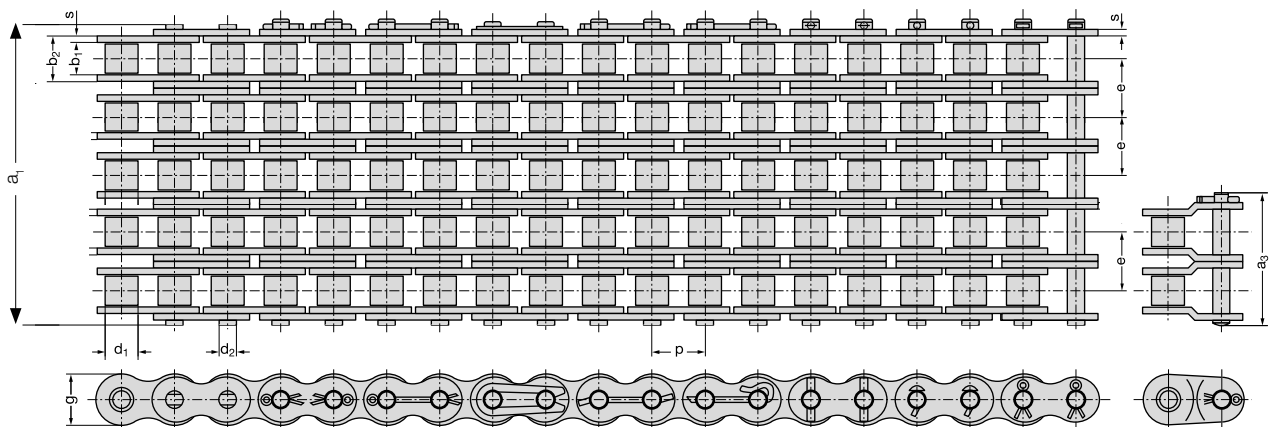

B Inner link A Outer link AS Outer link AT Outer link H Connecting link with shepherd's crook AK Outer link U Connecting link with cotter pin L Cranked link with cotter pin

Oilfiled - Roller Chains - ANSI

Approved Performance by API.

6-Strand Roller Chains



Pioneering corrosion protection

- 8 - 10 times better corrosion protection than the best competitor
- 100 % better than the competitors in the Stiffness Test in aggressive surroundings



Improved wear protection

- 8 - 12 % against the wear compared to previous version
- RexPro lubricant offers more than 150 % better protection against the cold welding



High dynamic loading resistance

- Ball drifting of the plate holes
- All chain parts are shot peened to improve fatigue resistance
- Link-Belt roller chains are pre-run-in under high load
- Rollers are high fatigue strength for resisting running-in impacts

Six-Strand Roller Chains, Ansi

Inch

Chain No.	Pitch	Dimension in inches										Bearing Area	Min. Ultimate strength	Weight	Outer Link	Loose Parts	
		p inch	b ₁ min.	d ₁ max.	d ₂ max.	b ₂ max.	g max.	e	a ₁ max.	a ₃ max.	s					A inch ²	F _B lbf
RC 50-6*	0.625	0.37	0.40	0.20	0.54	0.59	0.71	4.41	4.50	0.08	0.65	30,000	4.40	A	E	L	
RC 60-6*	0.750	0.50	0.47	0.23	0.70	0.70	0.90	5.49	5.58	0.09	0.99	42,900	6.08	A	U	L	
RC 80FR EW-6	1.000	0.62	0.63	0.31	0.89	0.93	1.15	7.23	7.34	0.13	1.66	76,500	11.43	H	L	H	
RC 100FR EW-6	1.250	0.74	0.75	0.38	1.08	1.15	1.41	8.77	8.87	0.16	2.44	120,000	16.71	H	L	H	
RC 120FR EW-6	1.500	0.99	0.88	0.44	1.39	1.36	1.79	11.13	11.27	0.19	3.66	172,000	24.19	H	L	H	
RC 140FR EW-6	1.750	0.99	1.00	0.50	1.46	1.61	1.93	11.95	12.10	0.22	4.38	233,000	32.99	H	L	H	

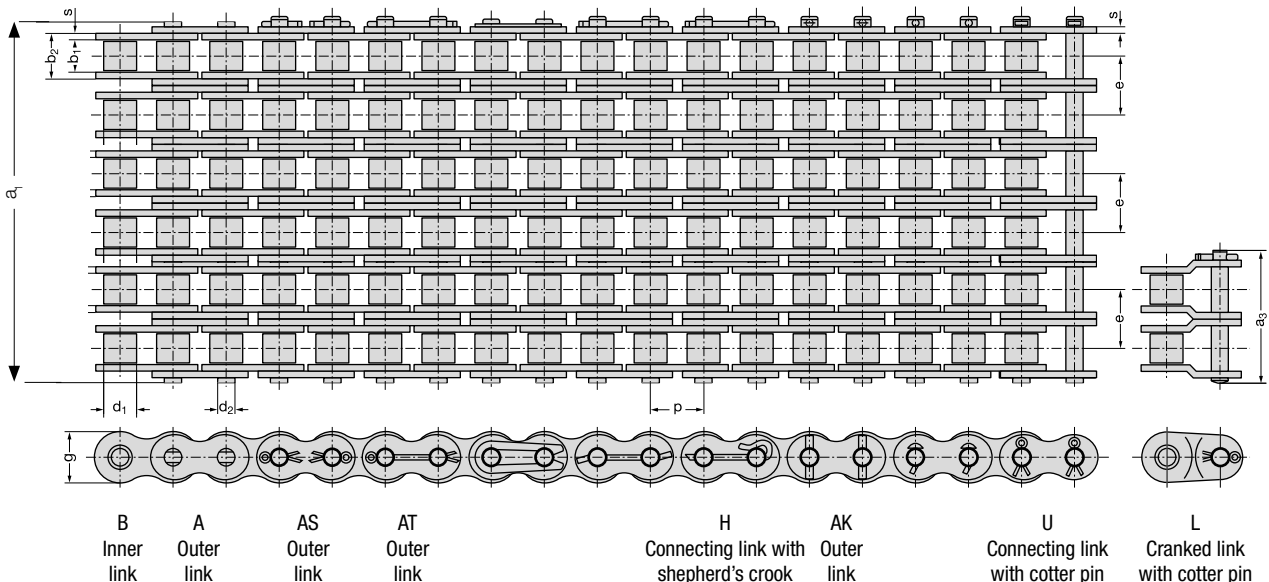

Oilfiled - Roller Chains - ANSI

6-Strand Roller Chains

Approved Performance by API.



Pioneering corrosion protection

- 8 - 10 times better corrosion protection than the best competitor
- 100 % better than the competitors in the Stiffness Test in aggressive surroundings



Improved wear protection

- 8 - 12 % against the wear compared to previous version
- RexPro lubricant offers more than 150 % better protection against the cold welding



High dynamic loading resistance

- Ball drifting of the plate holes
- All chain parts are shot peened to improve fatigue resistance
- Link-Belt roller chains are pre-run-in under high load
- Rollers are high fatigue strength for resisting running-in impacts



Metric

Six-Strand Roller Chains, Ansi

Chain No.	Pitch	Dimension in mm										Bearing Area A cm ²	Min. Ultimate strength F _B N	Weight ~q kg/m	Outer Link Stand. Type	Loose Parts	
		p mm	b ₁ min.	d ₁ max.	d ₂ max.	b ₂ max.	g max.	e	a ₁ max.	a ₃ max.	s					E	L
RC 50-6*	15.875	9.40	10.16	5.08	13.80	15.08	18.11	112.00	114.10	2.00	4.20	133,200	6.00	A	E	L	
RC 60-6*	19.050	12.57	11.91	5.94	17.70	17.70	22.78	139.30	141.70	2.40	6.36	190,800	8.30	A	U	H	
RC 80FR EW-6	25.400	15.75	15.88	7.92	22.50	23.50	29.29	183.60	186.30	3.20	10.74	340,200	15.60	H	L	H	
RC 100FR EW-6	31.750	18.90	19.05	9.53	27.40	29.20	35.76	222.70	225.20	4.00	15.72	531,000	22.80	H	L	H	
RC 120FR EW-6	38.100	25.22	22.23	11.10	35.30	34.40	45.44	282.40	286.40	4.70	23.64	762,000	33.00	H	L	H	
RC 140FR EW-6	44.450	25.22	25.40	12.70	37.00	40.80	48.87	303.20	303.20	5.50	28.27	1,034,000	45.00	H	L	H	

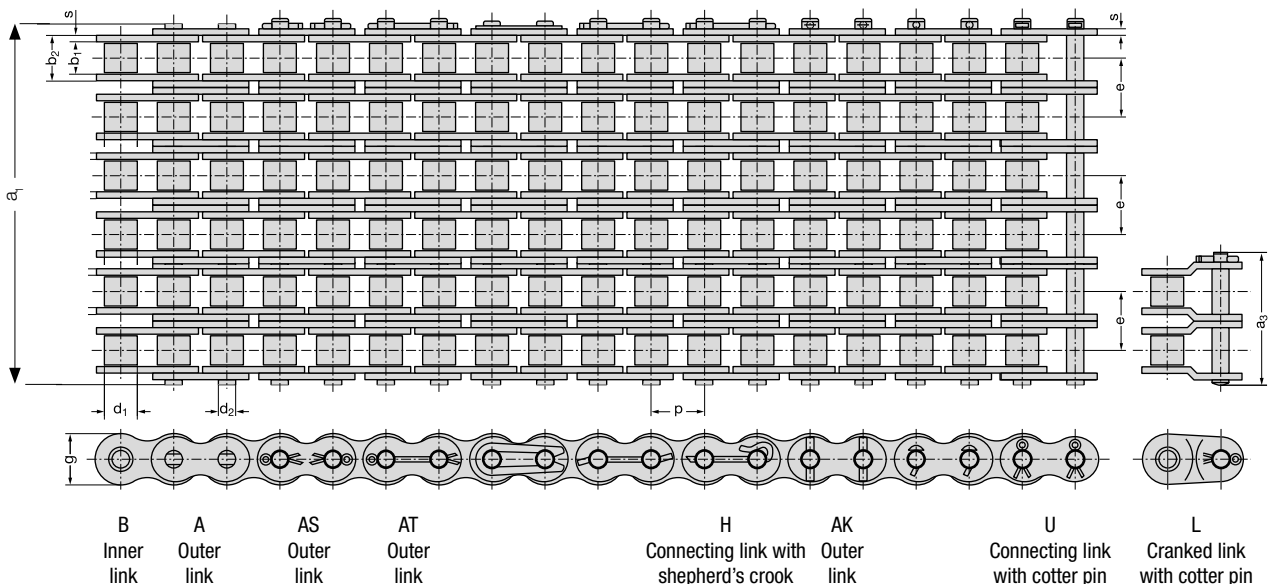

Oilfiled - Roller Chains - ANSI

Approved Performance by API.

8-Strand Roller Chains



Pioneering corrosion protection

- 8-10 times better corrosion protection than the best competitor
- 100% better than the competitors in the Stiffness Test in aggressive surroundings



Improved wear protection

- 8-12% against the wear compared to previous version
- RexPro lubricant offers more than 150% better protection against the cold welding



High dynamic loading resistance

- Ball drifting of the plate holes
- All chain parts are shot peened to improve fatigue resistance
- Link-Belt roller chains are pre-run-in under high load
- Rollers are high fatigue strength for resisting running-in impacts

Eight-Strand Roller Chains, Ansi

Inch

Chain No.	Pitch	Dimension in inches									Bearing Area A inch ²	Min. Ultimate strength F _B lbf	Weight ~q lb/ft.	Outer Link Stand. Type	Loose Parts	
		p inch	b ₁ min.	d ₁ max.	d ₂ max.	b ₂ max.	g max.	e	a ₁ max.	a ₃ max.					s	H
RC 100FR EW-8	1.250	0.74	0.75	0.38	1.08	1.15	1.41	11.60	14.53	0.16	3.25	160,000	22.28	H	L	H
RC 120FR EW-8	1.500	0.99	0.88	0.44	1.39	1.36	1.79	14.71	14.85	0.19	4.89	229,000	32.25	H	L	H
RC 140FR EW-8	1.750	0.99	1.00	0.50	1.46	1.61	1.93	15.80	15.96	0.22	5.84	311,000	43.98	H	L	H

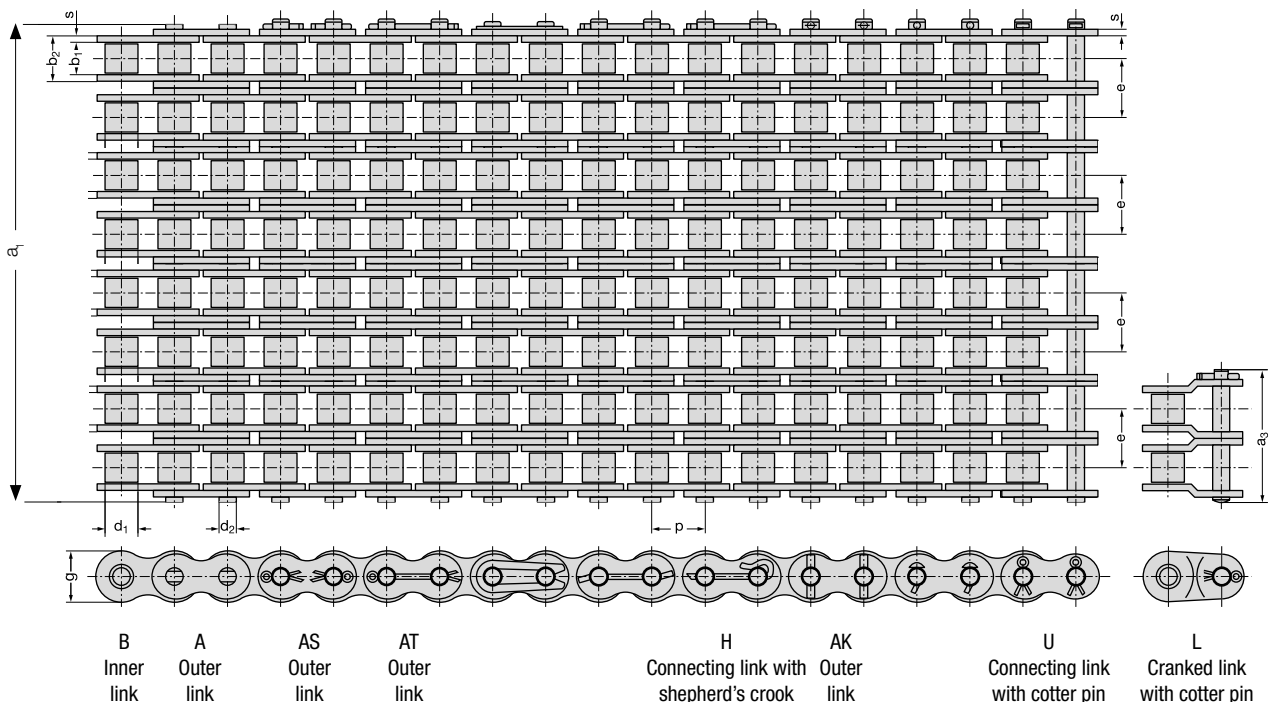

MODULE_06/D/2014/02 // No liability accepted for misprints or errors!

Oilfiled - Roller Chains - ANSI

Approved Performance by API.

8-Strand Roller Chains



Pioneering corrosion protection

- 8 - 10 times better corrosion protection than the best competitor
- 100 % better than the competitors in the Stiffness Test in aggressive surroundings



Improved wear protection

- 8 - 12 % against the wear compared to previous version
- RexPro lubricant offers more than 150 % better protection against the cold welding



High dynamic loading resistance

- Ball drifting of the plate holes
- All chain parts are shot peened to improve fatigue resistance
- Link-Belt roller chains are pre-run-in under high load
- Rollers are high fatigue strength for resisting running-in impacts



Metric

Eight-Strand Roller Chains, Ansi

Chain No.	Pitch	Dimension in mm									Bearing Area A cm ²	Min. Ultimate strength F _B N	Weight ~q kg/m	Outer Link Stand. Type	Loose Parts	
		p mm	b ₁ min.	d ₁ max.	d ₂ max.	b ₂ max.	g max.	e	a ₁ max.	a ₃ max.					s	L
RC 100FR EW-8	31.750	18.90	19.05	9.53	27.40	29.20	35.76	294.30	368.70	4.00	20.96	708,000	30.40	H	L	H
RC 120FR EW-8	38.100	25.22	22.23	11.10	35.30	34.40	45.44	373.30	376.80	4.70	31.52	1,016,000	44.00	H	L	H
RC 140FR EW-8	44.450	25.22	25.40	12.70	37.00	40.80	48.87	401.00	405.10	5.50	37.70	1,379,200	60.00	H	L	H

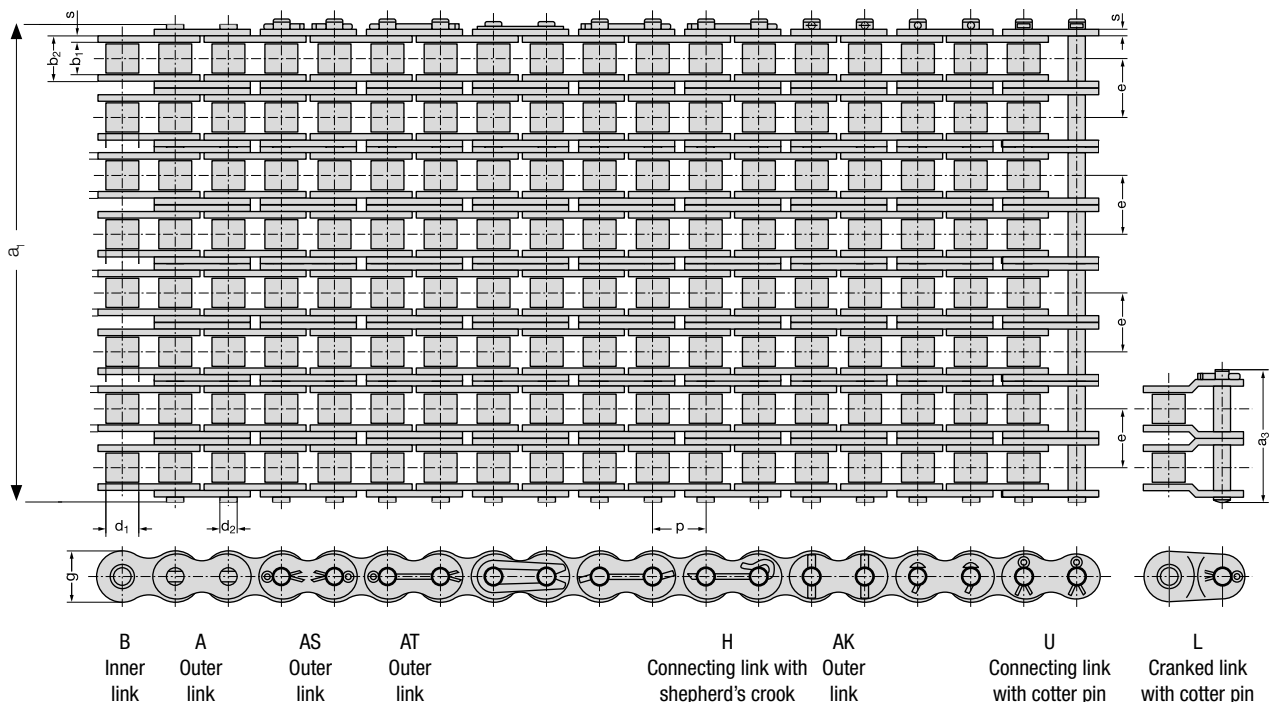

Oilfiled - Roller Chains - ANSI

Approved Performance by API.

10-Strand Roller Chains



Pioneering corrosion protection

- 8-10 times better corrosion protection than the best competitor
- 100% better than the competitors in the Stiffness Test in aggressive surroundings



Improved wear protection

- 8-12% against the wear compared to previous version
- RexPro lubricant offers more than 150% better protection against the cold welding



High dynamic loading resistance

- Ball drifting of the plate holes
- All chain parts are shot peened to improve fatigue resistance
- Link-Belt roller chains are pre-run-in under high load
- Rollers are high fatigue strength for resisting running-in impacts

Ten-Strand Roller Chains, Ansi

Inch

Chain No.	Pitch	Dimension in inches										Bearing Area A inch ²	Min. Ultimate strength F _B lbf	Weight ~q lb/ft.	Outer Link Stand. Type	Loose Parts	
		p inch	b ₁ min.	d ₁ max.	d ₂ max.	b ₂ max.	g max.	e	a ₁ max.	a ₃ max.	s					K	L
RC 100FR EW-10	1.250	0.74	0.75	0.38	1.08	1.15	1.41	14.26	14.53	0.16	4.06	199,000	28.95	H	K	L	
RC 120FR EW-10	1.500	0.99	0.88	0.44	1.39	1.36	1.79	18.08	18.41	0.19	6.11	286,000	42.07	H	K	L	

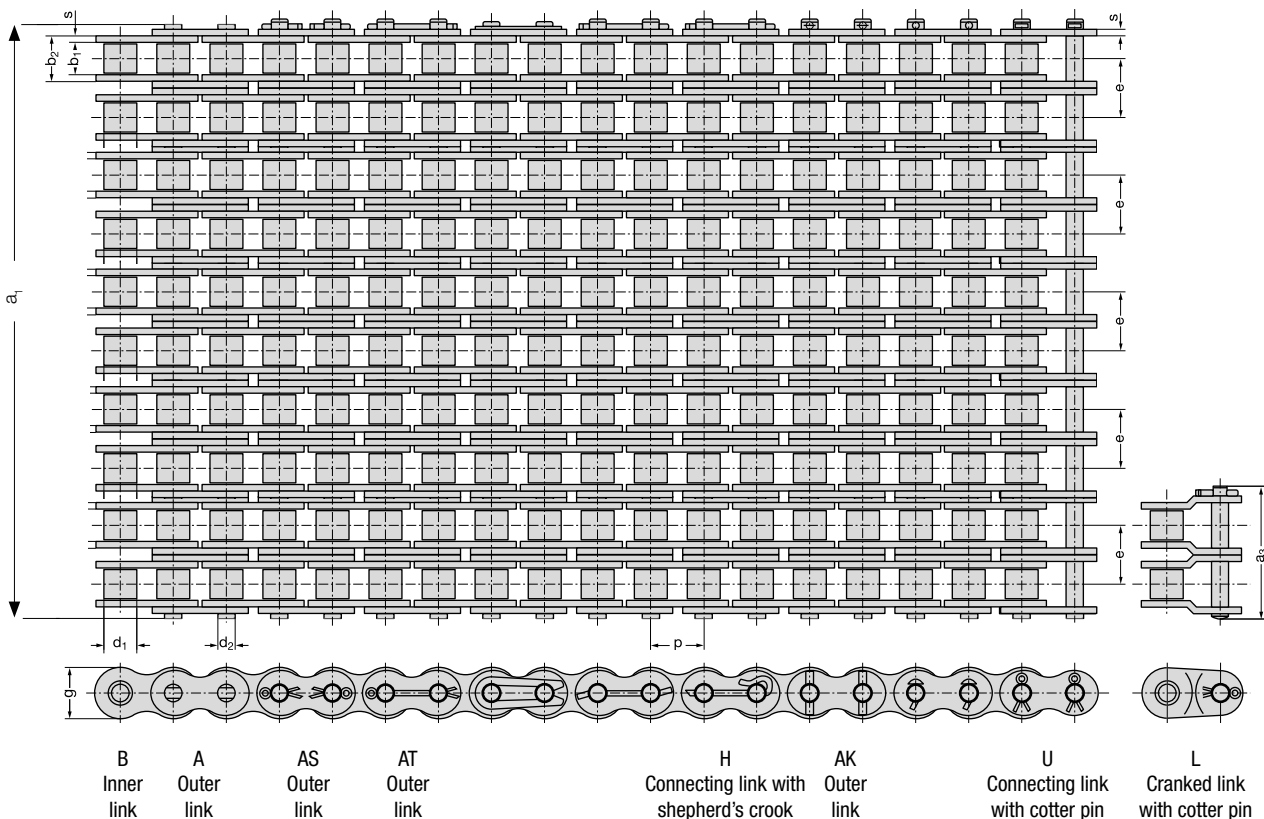

Oilfiled - Roller Chains - ANSI

Approved Performance by API.

10-Strand Roller Chains



Pioneering corrosion protection

- 8 - 10 times better corrosion protection than the best competitor
- 100 % better than the competitors in the Stiffness Test in aggressive surroundings



Improved wear protection

- 8 - 12 % against the wear compared to previous version
- RexPro lubricant offers more than 150 % better protection against the cold welding



High dynamic loading resistance

- Ball drifting of the plate holes
- All chain parts are shot peened to improve fatigue resistance
- Link-Belt roller chains are pre-run-in under high load
- Rollers are high fatigue strength for resisting running-in impacts



Metric Ten-Strand Roller Chains, Ansi

Chain No.	Pitch	Dimension in mm										Bearing Area A cm ²	Min. Ultimate strength F _B N	Weight ~q kg/m	Outer Link Stand. Type	Loose Parts		
		p mm	b ₁ min.	d ₁ max.	d ₂ max.	b ₂ max.	g max.	e	a ₁ max.	a ₃ max.	s					K	L	
RC 100FR EW-10	31.750	18.90	19.05	9.53	27.40	29.20	35.76	362.00	368.70	4.00	26.20	885,000	39.50	H	K	L		
RC 120FR EW-10	38.100	25.22	22.23	11.10	35.30	34.40	45.44	459.00	467.20	4.70	39.40	1,270,000	57.40	H	K	L		

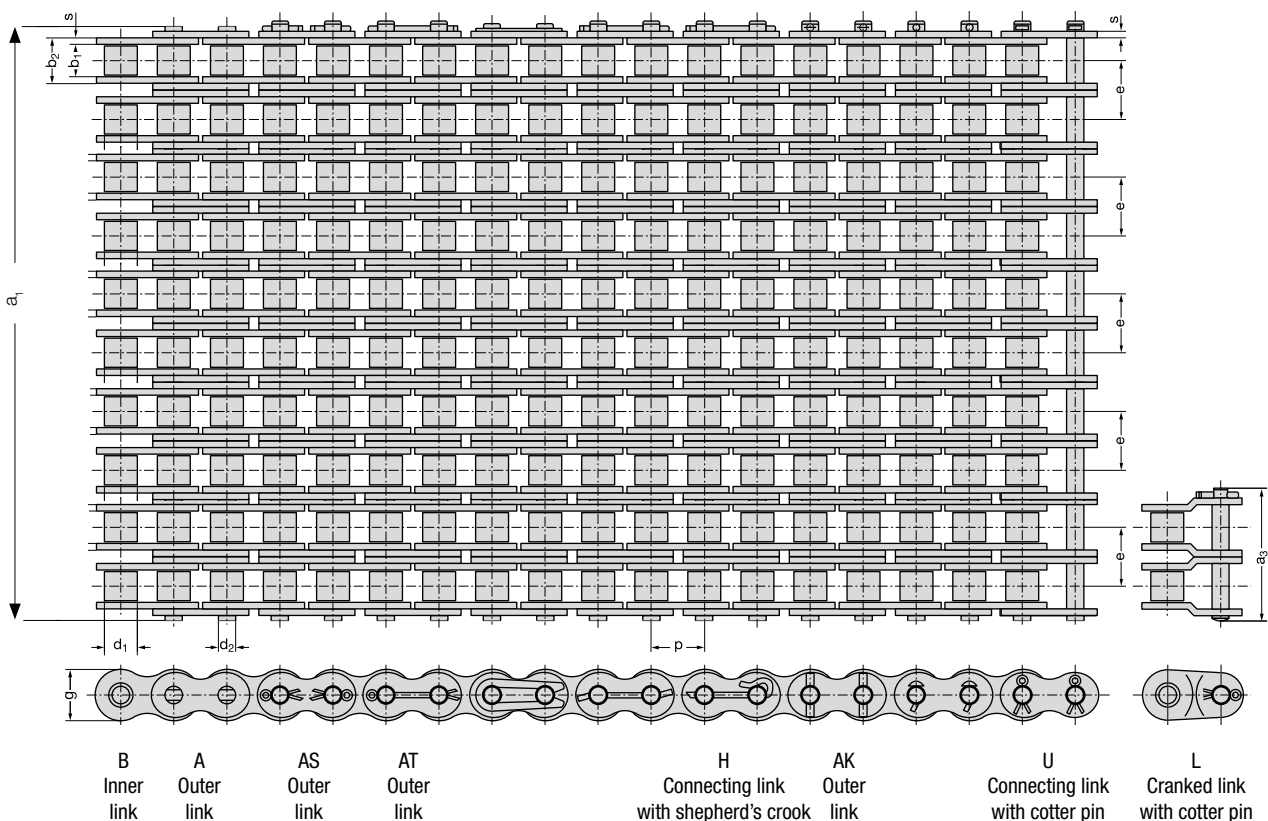

MODULE_06/D/2014/02 // No liability accepted for misprints or errors!

Oilfiled - Roller Chains - ANSI

Approved Performance by API.

12-Strand Roller Chains



Pioneering corrosion protection

- 8-10 times better corrosion protection than the best competitor
- 100% better than the competitors in the Stiffness Test in aggressive surroundings



Improved wear protection

- 8-12% against the wear compared to previous version
- RexPro lubricant offers more than 150% better protection against the cold welding



High dynamic loading resistance

- Ball drifting of the plate holes
- All chain parts are shot peened to improve fatigue resistance
- Link-Belt roller chains are pre-run-in under high load
- Rollers are high fatigue strength for resisting running-in impacts

Twelve-Strand Roller Chains, Ansi

Inch

Chain No.	Pitch	Dimension in inches									Bearing Area A inch ²	Min. Ultimate strength F _B lbf	Weight ~q lb/ft.	Outer Link Stand. Type	Loose Parts	
		p inch	b ₁ min.	d ₁ max.	d ₂ max.	b ₂ max.	g max.	e	a ₁ max.	a ₃ max.					s	K
RC 100FR EW-12	1.250	0.74	0.75	0.38	1.08	1.15	1.41	17.10	17.34	0.16	4.87	239,000	34.38	K	K	L

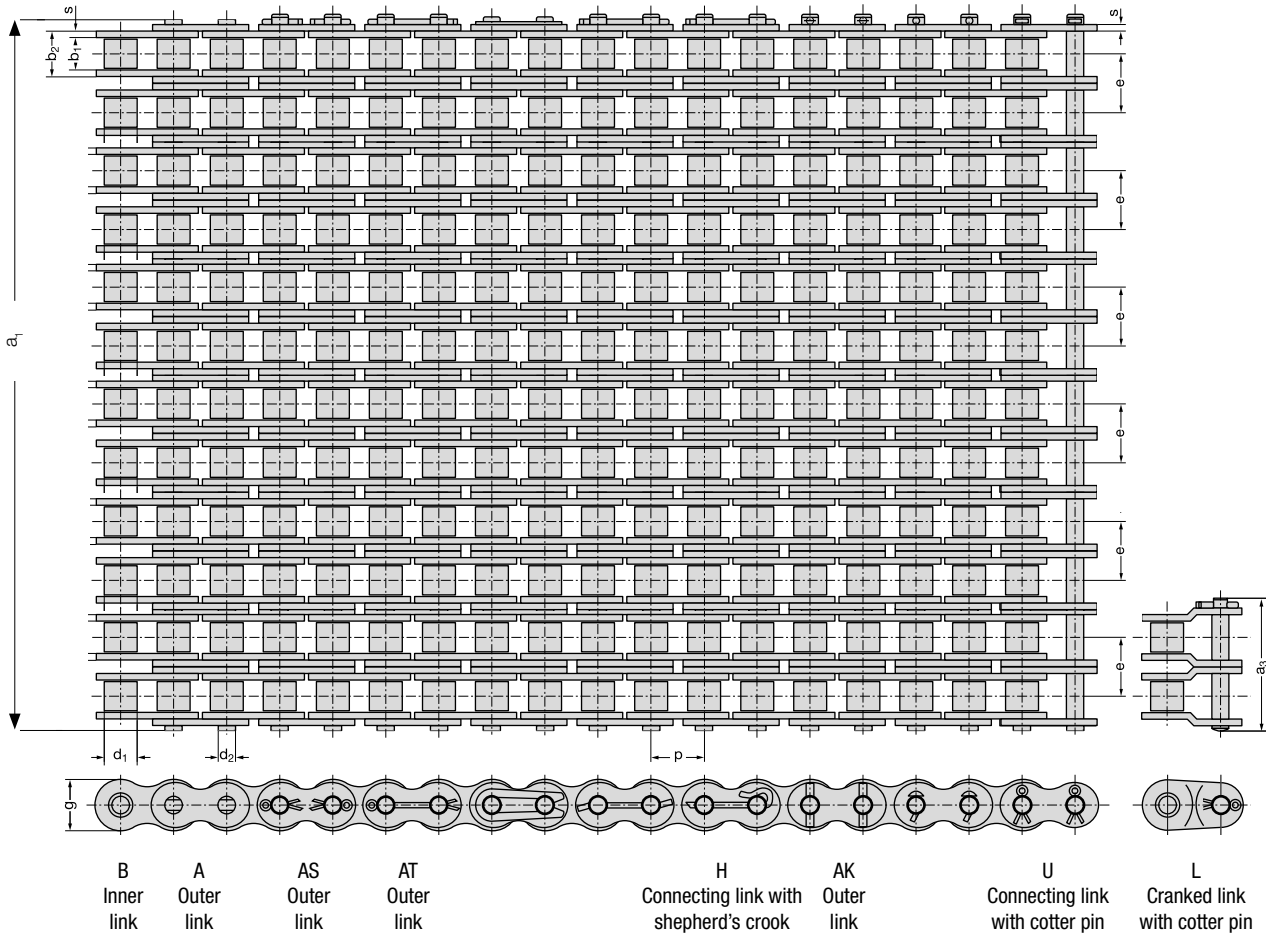

Oilfiled - Roller Chains - ANSI

Approved Performance by API.

12-Strand Roller Chains



Pioneering corrosion protection

- 8 - 10 times better corrosion protection than the best competitor
- 100 % better than the competitors in the Stiffness Test in aggressive surroundings



Improved wear protection

- 8 - 12 % against the wear compared to previous version
- RexPro lubricant offers more than 150 % better protection against the cold welding



High dynamic loading resistance

- Ball drifting of the plate holes
- All chain parts are shot peened to improve fatigue resistance
- Link-Belt roller chains are pre-run-in under high load
- Rollers are high fatigue strength for resisting running-in impacts



Metric Twelve-Strand Roller Chains, Ansi

Chain No.	Pitch	Dimension in mm									Bear- ing Area A cm ²	Min. Ultimate strength F _B N	Weight ~q kg/m	Outer Link Stand. Type	Loose Parts	
		p mm	b ₁ min.	d ₁ max.	d ₂ max.	b ₂ max.	g max.	e	a ₁ max.	a ₃ max.					s	K
RC 100FR EW-12	31.750	18.90	19.05	9.53	27.40	29.20	35.76	434.00	440.20	4.00	31.40	1,062,000	46.90	K	K	L

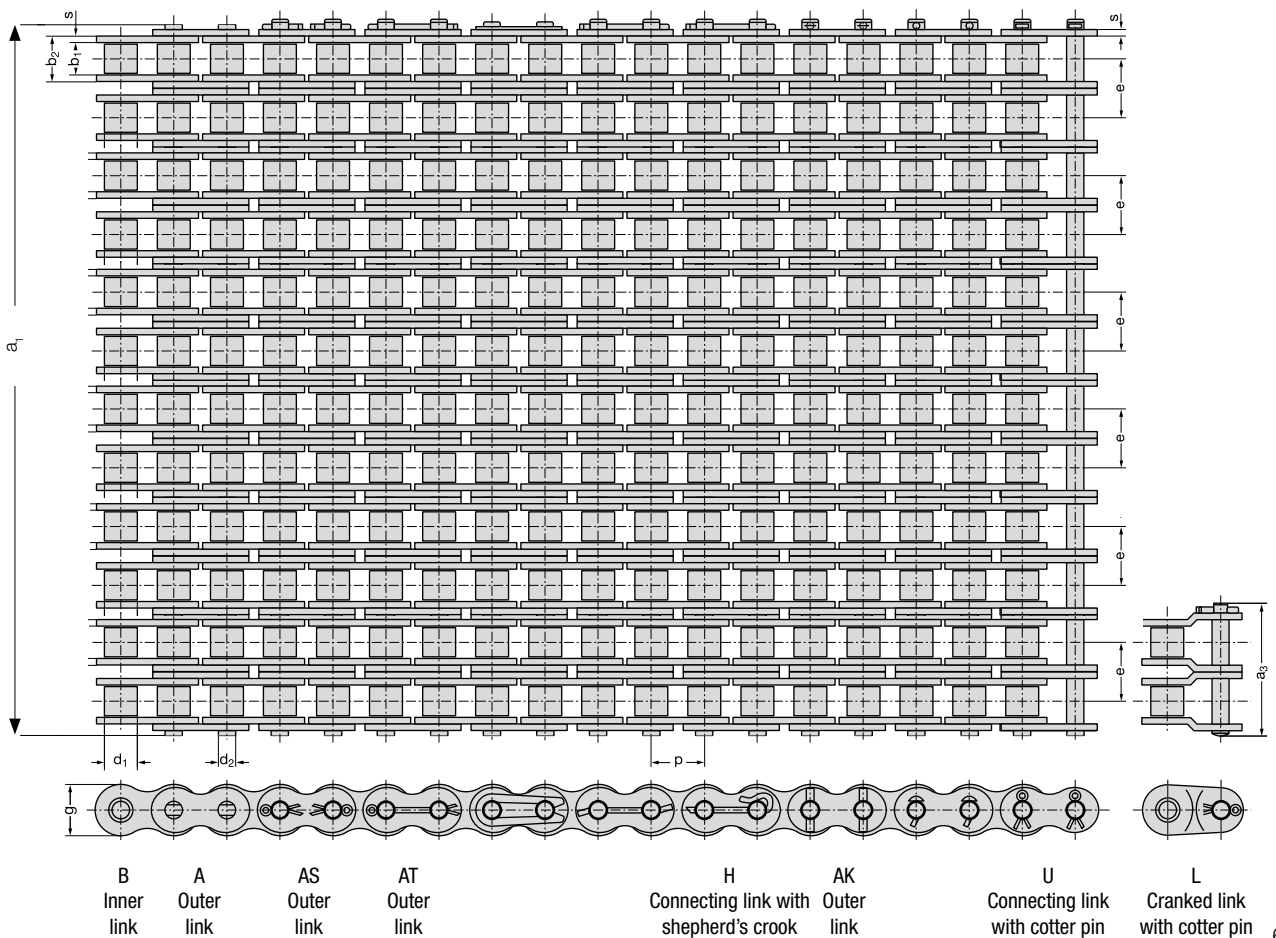

MODULE_06/D/2014/02 // No liability accepted for misprints or errors!

Overview Rexnord roller chains

Roller Chains

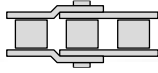

REXNORD

RexPro
RexPro lubrication
improved wear resistance
high fatigue resistance

- Outstanding protection against corrosion and wear
- Unique protection against chain joint stiffness
- Extremely eco-friendly

REXNORD

RexAthletic
good loading capacity
extended lubrication intervals

- Durable and low-maintenance
- Longer servicing intervals
- High loading capacity

REXNORD

RexCarbon
no lubrication
low noise

- Maintenance-free
- Low noise
- Eco-friendly

REXNORD

RexPlus
excellent corrosion resistance
high reliability

- Excellent resistance to rust and acids
- Highly reliable
- Fulfills hygiene requirements
- NSF H1 certification

REXNORD

RexPlusCarbon
no lubrication
excellent corrosion resistance

- Combination of RexPlus and RexCarbon
- Excellent resistance to rust and acids
- Maintenance-free
- NSF H1 certification

REXNORD

RexHiPro
good corrosion resistance
excellent loading capacity

- Outstanding corrosion resistance
- Long service life
- High loading capacity

Link-Belt
a brand of REXNORD

- The optimum choice for light and medium duty
- Good cost-benefit ratio
- High availability

REXNORD

RexProX
RexPro lubrication
improved wear resistance
high fatigue resistance

- Extremely high loading capacity
- Long service life
- Outstanding protection against corrosion and wear

Leaf Chains

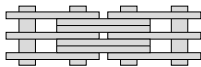

REXNORD

RexPro
RexPro lubrication
improved wear resistance
high fatigue resistance

- Outstanding protection against corrosion and wear
- Unique protection against chain joint stiffness
- Extremely eco-friendly

REXNORD

RexHiPro
good corrosion resistance
excellent loading capacity

- Outstanding corrosion resistance
- Long service life
- High loading capacity

REXNORD

RexAthletic
good loading capacity
extended lubrication intervals

- Durable and low-maintenance
- Longer servicing intervals
- High loading capacity

REXDL
a brand of REXNORD

- The optimum choice for light and medium duty
- Good cost-benefit ratio
- Good availability